

## GV-EBD8800 AI 8MP H.265 Super Low Lux WDR Pro IR Eyeball IP Dome



- AI Deep learning: AI Perimeter Protection & Classification (Human, Vehicle)
- 1/2.7" progressive scan low lux CMOS sensor
- Triple streams from H.265, H.264 or MJPEG
- Wide Dynamic Range Pro (WDR Pro)
- Min. illumination at 0.01 lux
- Up to 20 fps at 3840 x 2160
- Intelligent IR
- Day and night function (with removable IR-cut filter)
- 3-axis mechanism (pan / tilt / rotate)
- IR distance up to 30 m (100 ft)
- Ingress protection (IP67)
- Built-in micro SD card slot (SD / SDHC / SDXC / UHS-I, Class 10) for local storage
- DC 12 V / PoE (IEEE 802.3af)
- ONVIF (Profile S, G, T) conformant

### Introduction

The Eyeball Dome IP Camera is an outdoor, network camera equipped with an automatic IR-cut filter and IR LEDs for day and night surveillance. The camera supports H.265 video codec to achieve better compression ratio while maintaining high quality pictures at reduced network bandwidths. GV-EBD8800 adheres to IP67 standards, and can be powered through PoE.

Empowered by deep learning algorithms, AI technology distinguishes human and vehicles from other moving objects. Integrated with GeoVision Video Management Software (VMS), it supports AI perimeter protection, real time alert, events playback and more.

### Deep Learning Function

**AI Perimeter Protection**  
(Intrusion, Crossing Line  
Entering Area, Leaving Area)

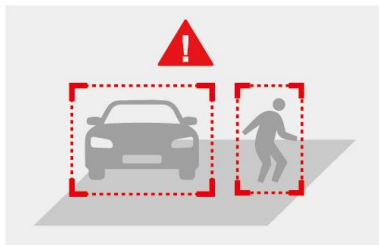

**AI Event Search**  
(VMS V18.3 or later)



**Note:** The integration of AI events of the camera to GV-VMS is coming soon.

## Dimensions

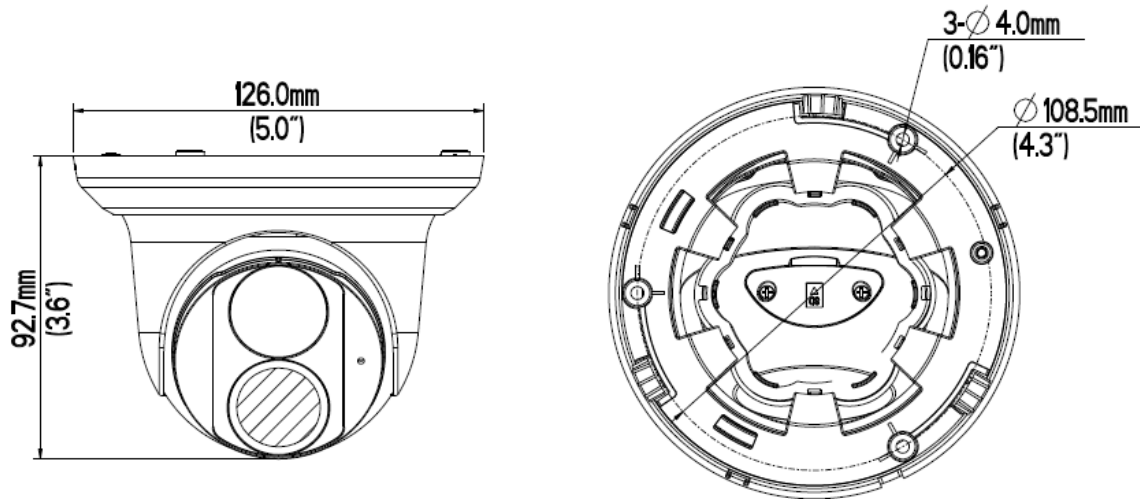

## Specifications

Camera		
Image Sensor	1/2.7" progressive scan low lux CMOS	
Picture Elements	3840 (H) x 2160 (V)	
Minimum Illumination	Color	0.01 Lux (F2.0, AGC ON)
	IR ON	0 Lux
Shutter Speed	Auto / Manual (1 ~ 1/100000 sec)	
White Balance	Auto / Manual	
Gain Control	Auto / Manual	
S/N Ratio	56 dB	
WDR	WDR Pro	
Dynamic Range	Up to 120 dB	
Optical Lens		
Megapixel	Yes	
Day / Night	Yes (with removable IR-cut filter)	
Lens Type	Fixed	
Focal Length	2.8 mm	
Maximum Aperture	F/2.0	
Mount	M12	
Horizontal FOV	112°	
Operation	Focus	Fixed
	Zoom	
	Iris	
IR LED Quantity	1 IR LED	
Max. IR Distance	30 m (100 ft)	
Operation		
Video Compression	H.265, H.264, MJPEG	
Video Streaming	Triple streams from H.265, H.264 or MJPEG	
Frame Rate	20 fps at 3840 x 2160, 30 fps at 3072 x 1728 / 2560 x 1440 / 1920 x 1080 (60 / 50 Hz) *The frame rate and performance may vary depending on the number of connections and data bitrates (different scenes).	
Video Analytics	Motion Detection, Tampering Alarm, Audio Detection *Tampering alarm, Audio detection are only accessible through the camera's Web interface, which can be used to trigger alerts such as e-mail and FTP.	
Image Setting	Brightness, Contrast, Saturation, Sharpness, Flicker-less, Image Orientation (Flip, Mirror, 0°, 90°, 180°, 270°-including Corridor format)	
Audio Compression	G.711	

Audio Support	One-way Audio	
<b>Deep Learning Function</b>		
AI Perimeter Protection	Intrusion, Crossing Line, Entering Area, Leaving Area (Human & Vehicle classification)	
<b>Video Resolution</b>		
Main Stream	3840 x 2160 (Default), 3072 x 1728, 2560 x 1440, 1920 x 1080	
Sub Stream	1920 x 1080, 1280 x 720, 720 x 576, 704 x 288, 640 x 360 (Default), 352 x 288	
Third Stream (Closed by Default)	720 x 576, 704 x 288, 640 x 360, 352 x 288	
<b>Network</b>		
Interface	10/100 Ethernet	
Protocol	ARP, DHCP, DDNS, DNS, DynDNS, FTP, HTTP, HTTPS, ICMP, IGMP, IPv4, NTP, PPPoE, RTCP, RTP, RTSP, SMTP, SNMP, TCP, UDP, UPnP, ONVIF (Profile G, S, T)	
<b>Mechanical</b>		
Camera Angle Adjustment	Pan	0° ~ 360°
	Tilt	0° ~ 90°
	Rotate	0° ~ 360°
Connectors	Power	DC Jack (DC 12 V, 1.25 A), PoE
	Audio	1 In (built-in microphone)
	Local Storage	Micro SD card slot (SD / SDHC / SDXC / UHS-I, Class 10) *UHS-II card type is not supported.
	Ethernet	RJ-45
<b>General</b>		
Environment Temperature	Start-up	-30°C ~ 60°C (-22°F ~ 140°F)
	Operation	
Humidity	0% ~ 95% (no condensation)	
Power Source	12 V DC / PoE (IEEE 802.3af)	
Max. Power Consumption	6.4 W	
Dimensions	Ø 126 x 92.7 mm (Ø 5.0" x 3.6")	
Weight	0.45 kg (0.99 lb)	
Ingress Protection	IP67	
Regulatory	CE, FCC, RoHS compliant	
<b>Web Interface</b>		
Installation Management	Web-based configuration	
Maintenance	Firmware upgrade through Web Browser or GV-IP Device Utility	
Access from Web Browser	Live View, Video Recording, Change Video Quality, Bandwidth Control, Image Snapshot, Defog, Text Overlay, Image Masking	
Language	Czech, English, French, German, Hungarian, Italian, Japanese, Polish, Portuguese, Russian, Spanish, Traditional Chinese	
<b>Software Application</b>		
Software Supported	GV-VMS (V17.4.1 / V18.2.1), GV-DVR / NVR (V8.9.1), GV-Control Center (V3.8.0), GV-Recording Server / Video Gateway (V2.0.0), GV-Edge Recording Manager Win version (V2.0.0), GV-Redundant / Failover Server (V1.2.0)	
Smart Device Access	GV-Eye for iOS and Android	
Live Viewing	Browser (IE, Edge, Chrome), Mobile App	









**Note:**

1. It is required to apply patch files to all or some of the supported software.
2. Do not use clothes or any ordinary material to clean the camera cover since they may result in scratches.
3. Specifications are subject to change without notice.

**Packing List**

- |                               |                          |
|-------------------------------|--------------------------|
| 1. GV-EBD8800 IR Eyeball Dome | 4. Drill Template Paster |
| 2. Waterproof Rubber Set      | 5. Download Guide        |
| 3. Screw Kit                  |                          |

## Accessories

Model No.	Name		Details
GV-Mount107 (must be used with GV-Mount212P)	Pendant Bracket		Dimensions: $\varnothing$ 120 x 334 mm ( $\varnothing$ 4.72" x 13.15") Weight: 0.74 kg (1.63 lb)
GV-Mount211P	Wall Mount and Junction Box		Dimensions: $\varnothing$ 233 x 126 x 126 mm ( $\varnothing$ 9.2" x 5" x 5") Weight: 1 kg (2.2 lb)
GV-Mount212P	Wall Box Mount		Dimensions: $\varnothing$ 126 x 36 mm ( $\varnothing$ 5.0" x 1.4") Weight: 0.22 kg (0.48 lb)
GV-Mount300-2	Convex Corner Mount		Dimensions: 137 x 233 x 160 mm (5.4" x 9.17" x 6.3") Weight: 1.65 kg (3.64 lb)
GV-Mount310-2	Concave Corner Mount		Dimensions: 111.2 x 369.9 x 210 mm (2.6" x 11.4" x 6.6") Weight: 1.65 kg (3.64 lb)
GV-Mount420 (must be used with GV-Mount211P)	Pole Mount Bracket		Dimensions: $\varnothing$ 120 x 120 x 53.4 mm ( $\varnothing$ 4.7" x 4.7" x 2.1") Weight: 0.45 kg (0.99 lb) Steel Strap Diameter: $\varnothing$ 67 ~ 127 mm ( $\varnothing$ 2.6" ~ 5")
GV-Mount704 (must be used with GV-Mount107)	Extension Tube		Dimensions: $\varnothing$ 3.5 x 10 or 20 or 30 or 50 cm ( $\varnothing$ 1.38 x 3.9 or 7.9 or 11.8 or 19.7") Weight: 225 g or 360 g or 500 g or 780 g (0.5 lb or 0.79 lb or 1.1 lb or 1.72 lb)
GV-PA191	Power over Ethernet (PoE) Adapter		GV-PA191 is a Power over Ethernet (PoE) adapter designed to provide power to the IP device through a single Ethernet cable.
GV-PoE Switch	GV-PoE Switch is designed to provide power along with network connection for IP devices. GV-PoE Switch is available in various models with different numbers and types of ports.		
Power Adapter	Contact our sales representatives for the countries and areas supported.		