

User Manual

Color Video Door Phone CDV-43KM / CDV-43KM2



- Thank you for purchasing COMMAX products.
- Please carefully read this User's Guide (in particular, precautions for safety) before using a product and follow instructions to use a product exactly.
- The company is not responsible for any safety accidents caused by abnormal operation of the product.



Table of Contents

1. Greetings	1
2. Warnings and Cautions.....	2
3. Part Names and Functions	4
4. Package Contents	4
5. Wiring and Connection Instructions.	4
6. Operation	5
7. Start Menu	7
8. Installation	17
9. Specifications and Features.....	18
10. Safe Operation guide	18



1. Greetings

- Thank you for Purchasing COMMAX Products
- Please carefully read this User's Manual (in particular, precautions for safety) before using a product and follow instructions to use a product exactly.



2. Warnings and cautions

Please follow the things described below in order to prevent any danger or property damage.

	Warning	It may cause a serious damage or injury if violated.
	Caution	It may cause a minor damage or injury if violated.

	Prohibition.
	No disassembly
	No touch
	Must follow strictly.
	Shows plugging out the power cord without an exception
	Shows the warning and caution for an electric shock.
	Shows the warning and caution for a fire.

Warning

Power & Installation

Please don't use several products at the same time on one power socket.

- It may cause a fire due to an abnormal overheating.

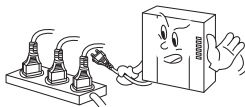

Please don't bend the power cable excessively or it may cause an electric shock.

- fire when using a damaged power cable.

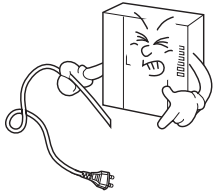

Please don't handle the power cable with a wet hand.

- It may cause an electric shock.

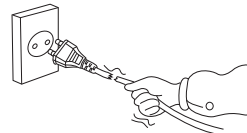

Please plug out the power cable from the socket when not using it for a long period of time.

- It may shorten the product lifespan or cause a fire.

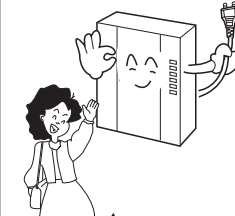

Please don't install the product in the place where there is much oil, smoke or humidity.

- It may cause an electric shock or fire.

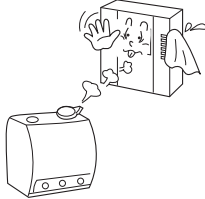

Please don't install the product with the lightning and thunder.

- It may cause an electric shock or fire.

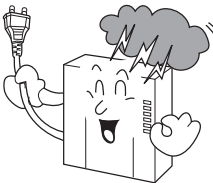

Please don't use and connect this product with other products with different rated voltage.

- It may cause a disorder or fire.

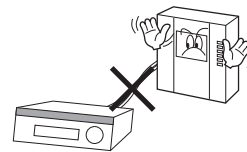

When installing the product that generates heat, please install the product away from the wall (10cm) for the ventilation.

- It may cause a fire due to the increased internal temperature.

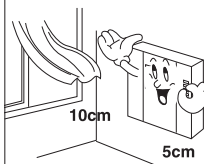

! Warning

Cleaning & Use

Please don't disassemble, repair or rebuild this product arbitrarily (please contact the service center if a repair is needed).

- It may cause an electric shock or fire.

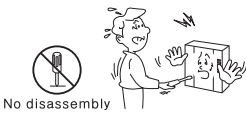

If an abnormal sound, burning smell or smoke is coming out of the product, please plug out the power cable and contact a service center.

- It may cause an electric shock or fire.

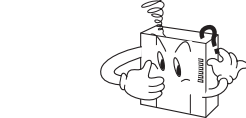

Please don't insert any metallic or burnable materials into the ventilation hole.

- It may cause an electric shock or fire.

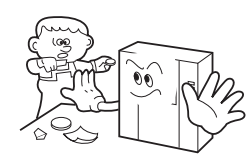

Please use only the designated batteries for the products of using DC power.

- It may cause an electric shock or fire.

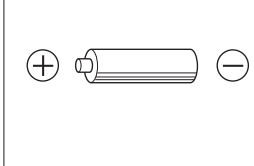

! Caution

Power & Installation

Please plug the power cable firmly into the inner end

- It may cause a fire.

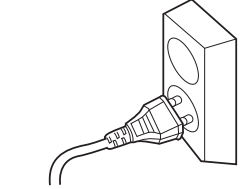

Please hold the plug tightly when unplugging the power cable (a part of the copper wire may be disconnected if the grabbing is only made on the cord when pulling out the cable).

- It may cause an electric shock or fire



When connecting the power cables after cutting the cable, please install the product with power off

- It may cause an electric shock or fire

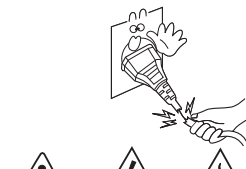

When installing the product, please fix it firmly while using the wall-mounting unit and screws.

- It may cause an injury from the falling object.

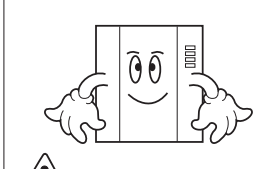

Please be careful when using an AC circuit breaker since there is a possibility of an electric shock.

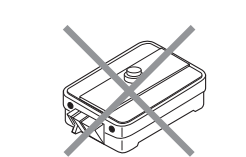

Please check the use voltage and current for the DC-only products and use the appropriate rectifier.

- It may cause a fire.



Please avoid direct rays of the sun or heating devices at a time of installation.

- It may cause a fire.

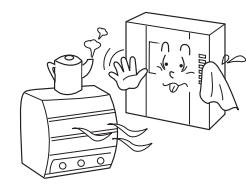

Please don't install the product on an unstable place or small support board.

- It may cause an injury if it falls down while in use.



Cleaning & Use

When cleaning the product, please rub it with a soft and dry cloth after plugging out the power cable. (Please don't use any chemical products such as wax, benzene, alcohol or cleanser.)



Please don't drop the product on the ground and don't apply a shock.

- It may cause a failure.

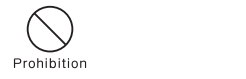
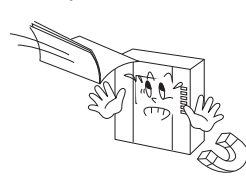

Please use the designated connection cable within the maximum calling distance designated for the product

- It may reduce the product performance.



3. Parts Names

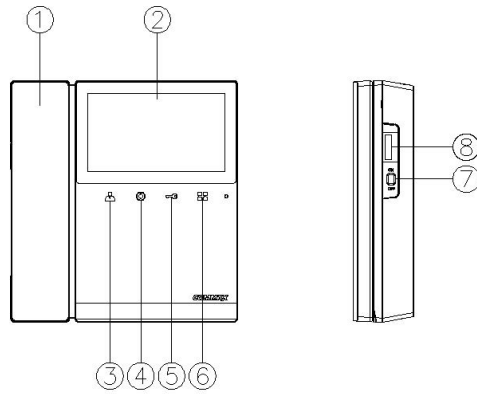

- ① HANDSET
- ② TFT-LCD
- ③ MONITORING BUTTON
- ④ INTERPHONE BUTTON
- ⑤ DOOR OPEN BUTTON
- ⑥ MENU BUTTON
- ⑦ POWER SWITCH
- ⑧ MICRO SD-CARD SLOT

4. Package Contents

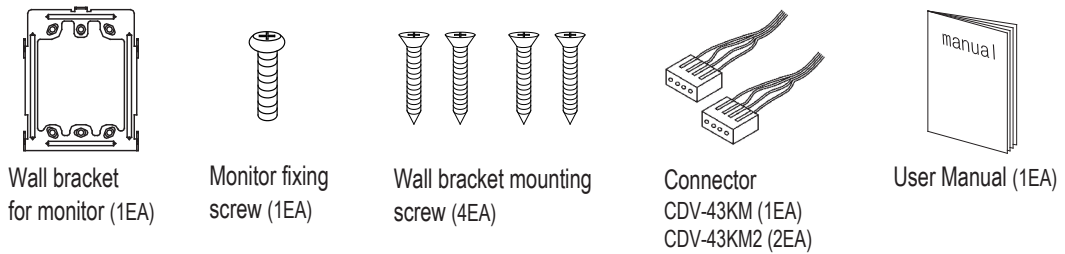

5. Wiring and Connection Instructions

▷ Polarity of the camera connector

- 1. Red: Talk (Audio)
- 2. Blue: GND
- 3. Yellow: Power (+12V)
- 4. White: Video

▷ Polarity of interphone connector

- 1. Red: Talk (Audio)
- 2. Blue: GND
- 3. Yellow: Power (+14V)
- 4. White: Call signal

[CDV-43KM]

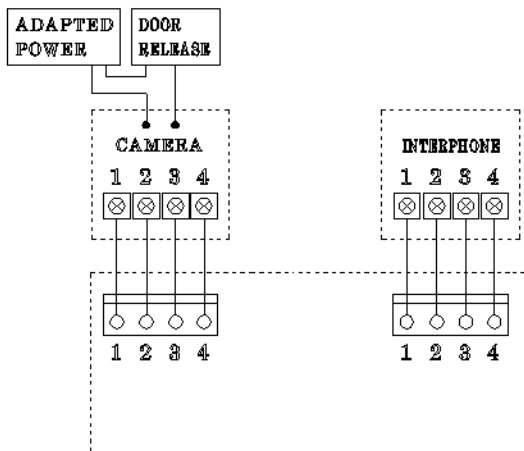

[CDV-43KM2]

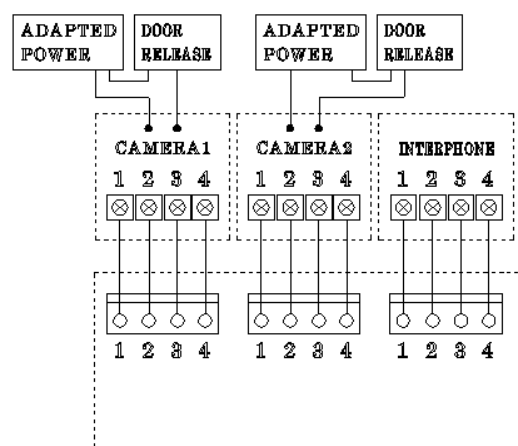



6. Operation

※ **Caution** : Do not hold the handset at your ear when you press hook switch to switch call.

1. Calling of visitor

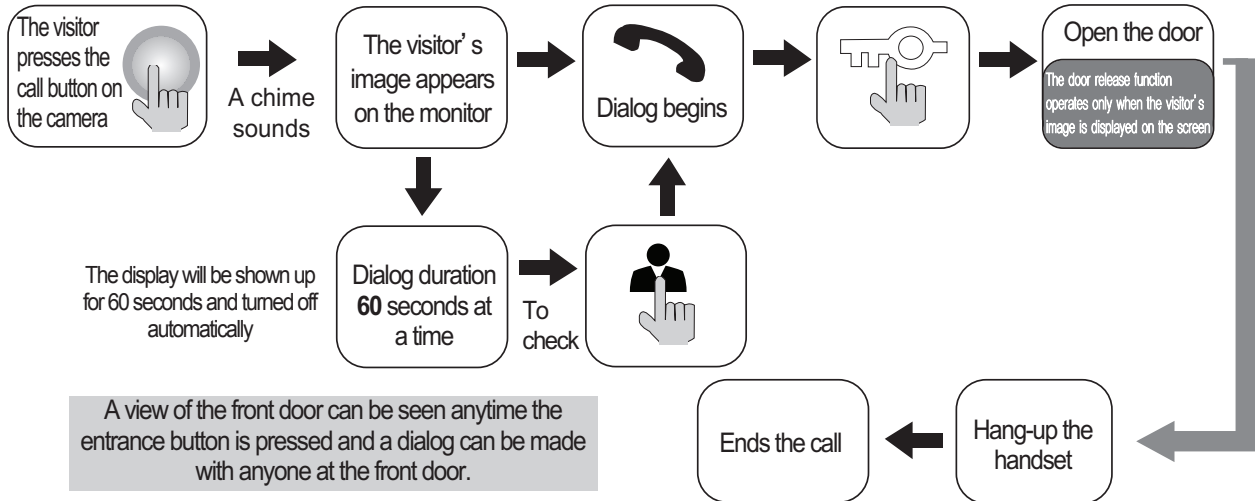

* In case of connecting two cameras

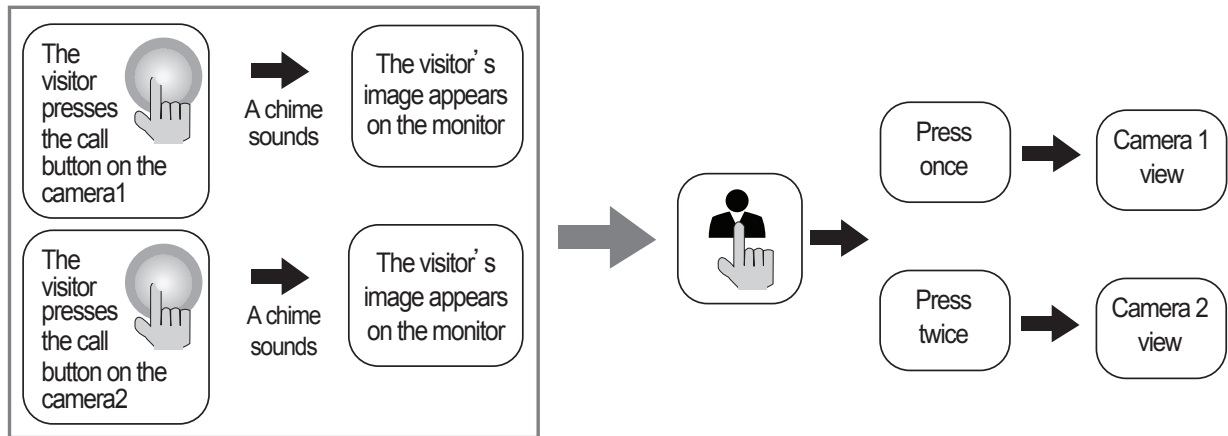

2. Communication with the optional Interphone

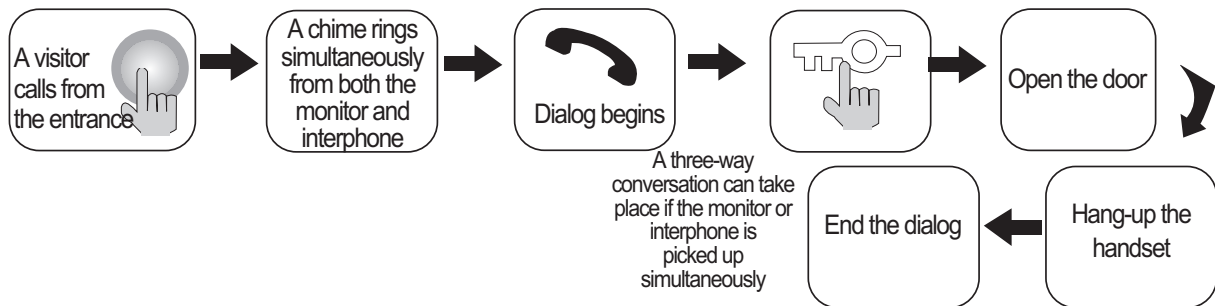

Dialog between the interphone and camera is possible only when the visitor's image is visible on the monitor screen.

3. Monitoring : function to see the image of visitor in the entrance.

(stand-by mode) Operation

- By pressing the Monitor button repeatedly, the monitor will work as following in order.

Camera 1 → (Camera 2) → OFF → Camera 1

(On talking mode)Operation

- By pressing Monitor button repeatedly, the monitor will work as following in order.

Camera1 → (Camera 2) → Camera 1 → (Camera 2)

4. GUI Description

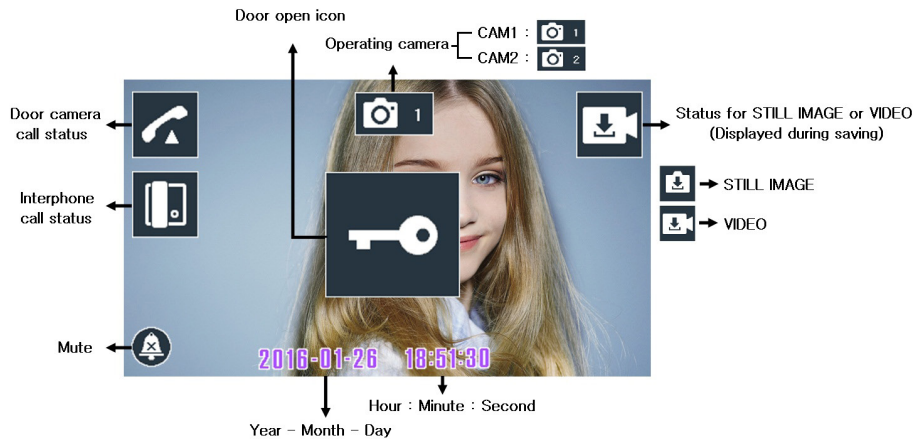

- During the call, User can record the images displaying on LCD monitor by pushing the 'Menu' button.
- Recorded images are defined two types, first as 'STILL IMAGE' and second as 'VIDEO' by SAVING TYPE.
- During recording 'VIDEO', User can stop recording by pushing the 'Menu' button.

Caution 1)



When there is no space left for recording 'VIDEO' inside of SD card : The icon 'FULL' will be displayed on LCD monitor.

Then CDV-43KM(2) will be automatically deleting the oldest VIDEO and saving the newest VIDEO instead.

Caution 2)



When there is no SD card inserted

: The icon 'No SD' will be displayed on LCD monitor.

STILL IMAGE can be saved in embedded memory. VIDEO can not saved in embedded memory. Once SD card is inserted, then STILL IMAGE or VIDEO can be saved.

7. Start Menu

: User can start Main Menu by touching Menu button from Standby mode in LCD monitor.

: Main Menu consists of two features, first 'VISITOR' and second 'CONFIG'



User can finish Main Menu by touching Menu button and LCD monitor will go back to Standby mode.

(1) 'VISITOR' 

User can execute 'CHECKING VISITOR' Menu by touching Interphone button

(2) 'CONFIG' 

User can execute 'CONFIG' Menu by touching Open button

(User can go back to Standby mode by touching Menu button.)

7-1. CHECKING VISITOR

User can see below image in LCD monitor by selecting the icon  .

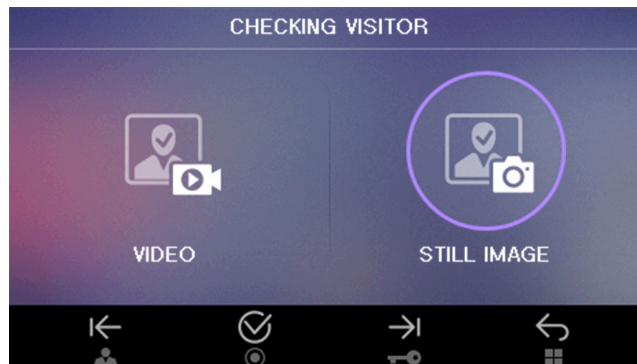

(1) Icon description

 : Move(Monitoring button) – Move to left

 : Move (Door open button) - Move to right

 : Select (Interphone button) – Execute

 : Previous (Menu button) – Go back to Main Menu

(2) 'VIDEO': User can check 'VIDEO'.

(3) 'STILL IMAGE': User can check 'STILL IMAGE'.

7-1-1 Recorded image checking

User can choose 'CHECKING VISITOR' Menu. User can choose then 'VIDEO' or 'STILL IMAGE' based on need. Then User can see recorded image

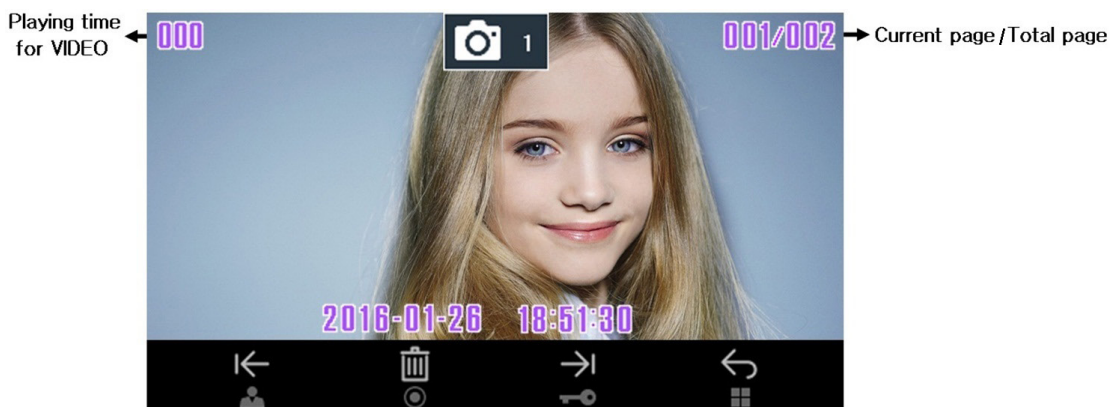

< Recorded image display >

(1) Icon description

 : Go back to previous image

- User can go back to previous image in 'VIDEO' or 'STILL IMAGE'

 : Move to next image – User can move to next image.

 : Delete – User can see Pop-up image displaying 'Delete' current image displayed.

(When deleting current images, User can select YES/NO by touching the buttons

 ,  ,  , accordingly.)

 : Previous – User can go back to 'CHECKING VISITOR'

7-2. CONFIG

User can see below image in LCD monitor by selecting the icon  in Main Menu.

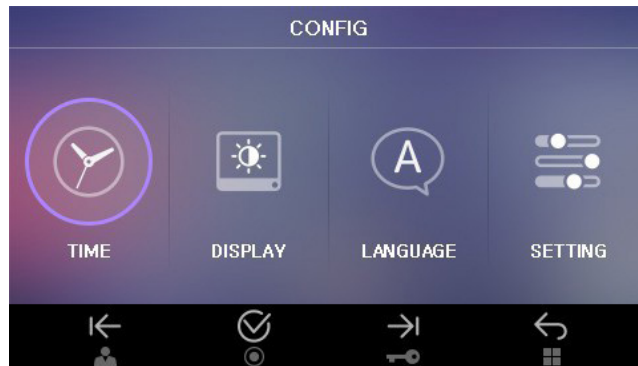

(1) Icon description

 : Move to left - User can select TIME, SETTING, LANGUAGE, DISPLAY based on need.

 : Move to right - User can select TIME, DISPLAY, LANGUAGE, SETTING based on need.

 : Select - User can select any feature. Then move to selected feature.

 : Previous – Go back to Main Menu

(2) 'TIME': User can adjust time.

(3) 'DISPLAY': User can adjust display.

(4) 'LANGUAGE': User can select language.





(5) 'SETTING': User can select saving type, saving method, volume change, and initialization.

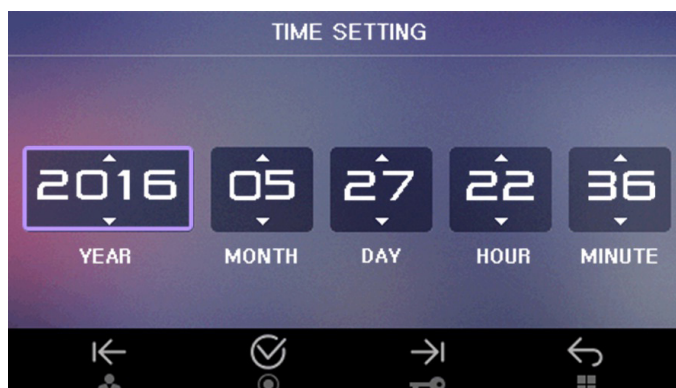

7-2-1. TIME SETTING

User can see below image in LCD monitor by moving and selecting the right icon 'TIME' in CONFIG.



(1) Icon description

-  : Move to left – Move from YEAR, MINUTE, HOUR, DAY and lastly MONTH.
(Move from right after YEAR)
-  : Move to right – Move from YEAR, MONTH, DAY, HOUR and lastly MINUTE.
(Move from left after YEAR)
-  : Select – Select to feature to change. When selecting, the feature will be blinking.
-  Decrease (Monitoring  button) / Increase (Door open button)



(After adjustment, complete theset with  button.)
-  : Previous – User can go back to 'CONFIG'.

7-2-2. DISPLAY SETTING

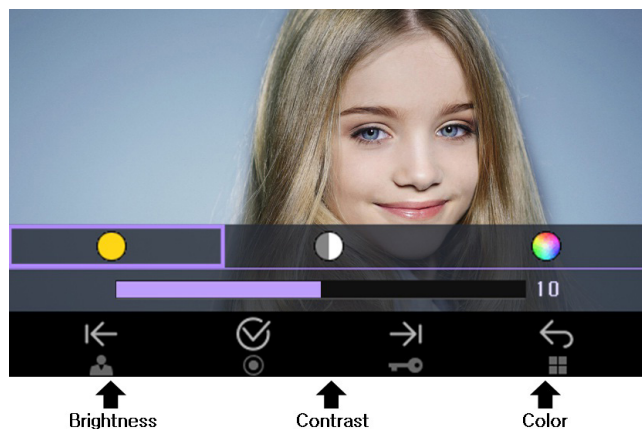
User can see below image in LCD monitor by moving and selecting the right icon 'DISPLAY' in CONFIG.



(1) Icon description

-  : Move to left - Move from Brightness, Color, Contrast.
(Move from right after Brightness)
-  : Move to right - Move from Brightness, Contrast, Color.
(Move from left after Brightness)

 : Select - Select to feature to change. When selecting, the feature will be blinking.

 Decrease the configuration value.

 Increase the configuration value.

(After adjustment, complete it with  button.)

 : Previous – User can go back to ‘SETTING’

7-2-3. LANGUAGE SETTING

User can see below image in LCD monitor by moving and selecting the right icon ‘LANGUAGE’ in CONFIG.



(1) Icon description

 : Move to left – Move from Chinese, Arabic, Persian, Polish, Spanish, Russian, English and lastly Korean.

 : Move to right – Move from Korean, English, Russian, Spanish, Polish, Persian, Arabic and lastly Chinese.

 : Select - Select to feature to change. When changed, it will be saved automatically.

 : Previous – User can go back to ‘CONFIG’

7-2-4. SETTING

User can see below image in LCD monitor by moving and selecting the right icon 'SETTING' in CONFIG.

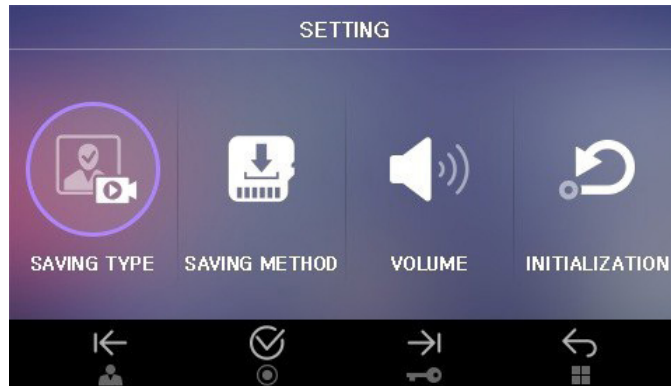

(1) Icon description

← : Move to left - Move from right feature to left.

→ : Move to right - Move from left feature to right.

✓ : Select - Select to feature to change.

↶ : Previous – User can go back to 'CONFIG'

(2) SAVING TYPE

(3) SAVING METHOD

(4) VOLUME

(5) INITIALIZATION

7-2-4-1 SAVING TYPE

User can see below image in LCD monitor by moving and selecting the right icon 'SAVING TYPE' in SETTING mode. (Factory default setting: STILL IMAGE)

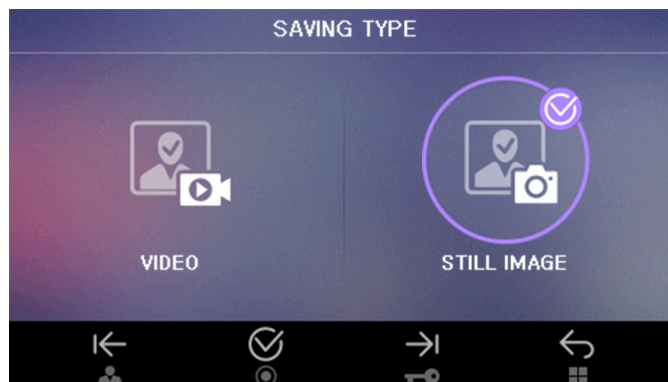

(1) Icon description

← , → : Move – Move from STILL IMAGE and to VIDEO.

☑ : Select - Select to feature to change. (When seleted, Icon ☑ will be dsplayed.)

↶ :Previous – User can go back to 'SETTING'

(2) VIDEO: Saved as VIDEO

- The maximum time of saving varies to the size of SD card memory.

(3) STILL IMAGE: Saved as captured STILL IMAGE.

- The maximum cut of STILL IMAGE is128 images. (50 images maximum without SD card)

7-2-4-2. SAVING METHOD

User can see below image in LCD monitor by moving and selecting the right icon 'SAVING METHOD' in SETTING mode. (Factory default setting: AUTOMATIC SAVE)

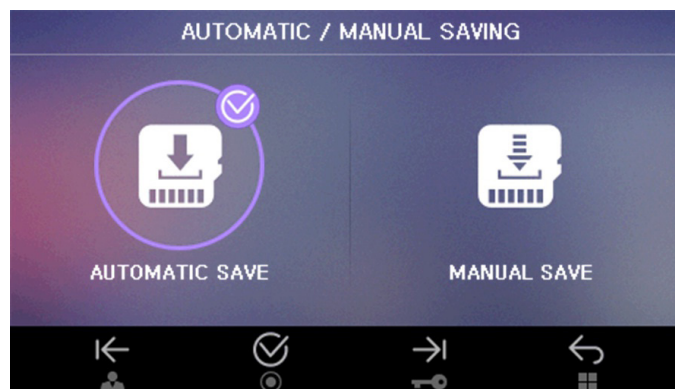

(1) Icon description

← , → : Move - Move from AUTOMATIC SAVE to MANAL SAVE.

☑ : Select - Select to feature to change. (When seleted, Icon ☑ will be diplayed.)

↶ : Previous – User can go back to 'SETTING'

(2) AUTOMATIC SAVE

→ User can save 'VIDEO' or 'STILL IMAGE' automatically using this mode.

In this mode, 'VIDEO' will be saved once. User can stop saving 'VIDEO' by touching Menu button. And User can start saving 'VIDEO' again by touching Menu button.

In this mode, 'STILL IMAGE' will be also saved once. User can start saving 'STILL IMAGE' one more time again by touching Menu button.

(3) MANUAL SAVE

→ In this mode, User should touch Menu button to save 'VIDEO' or 'STILL IMAGE'.

→ When call is on and LCD monitor is on, then User can touch Menu button save.

7-2-4-3. VOLUME

User can see below image in LCD monitor by moving and selecting the right icon 'VOLUME' in SETTING mode.

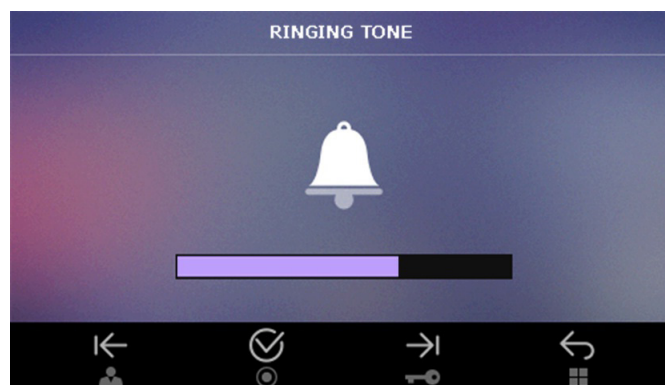

(1) Icon description

 : Volume UP - Increase volume.

 : Volume Down - Decrease volume.

 : Select - Save volume adjusted.

 : Previous – User can go back to 'ETC SETTING'

• Caution

When User decrease the volume to the lowest, User can see the Icon .



In this case, User can not hear call volume and this indicates 'Mute'

7-2-4-4. INITIALIZATION

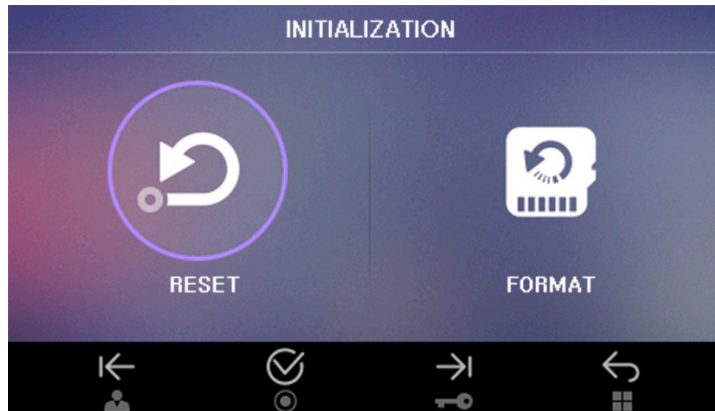
User can see below image in LCD monitor by moving and selecting the right icon 'INITIALIZATION' in SETTING mode.



(1) Icon description

 ,  : Move - Move from RESET to FORMAT.

 : Select - Execute

 : Previous – User can go back to 'SETTING'

(2) RESET : This is the feature User can reset the product.

User can reset the product by selecting the icon, 'RESET'

RESET : DISPLAY, LANGUAGE, SETTING (SAVING TYPE, SAVING METHOD, VOLUME, INITIALIZATION)

(TIME can not be reset.)

(3) FORMAT : This is the feature User can format SD card.

User can format SD card by selecting the icon, 'FORMAT'

When FORMAT feature is executed, all data in SD card will be deleted. [Please, be noted]

*** Folder and File management ***

⇒ Firstly insert SD CARD and execute 'FORMAT' menu and create the folder.

⇒ Creation of basic folder

PICTURE : Still cut image folder / VIDEO : Video saving folder

(BKUP_PIC : STILL IMAGE back up from embedded memory)

→ Recorded file name and format [Example]

STILL IMAGE	2016-01-27_1623241.jpg			
	2016-01-27_1623242.jpg			
VIDEO	2016-01-27_1623241.avi			
	2016-01-27_1623242.avi			
Description	Date	Time	Source	File Type
	16/01/27	16H23M24S	1,2 = Door 1,2	STILL IMAGE (*.jpg) VIDEO (*.avi)
Remark	<p>→ The maximum cuts of STILL IMAGE can be saved: 128cuts Once over 128 cuts, then automatically deleting the oldest image and saving the newest image instead.</p> <p>→ Video is recorded up to maximum space availability of the SD Card.</p> <p>→ If not have Micro SD Card you can save in the memory of products If you insert Micro SD Card, after data backup you can save in Micro SD</p> <p>→ User can delete one by one by selecting each file. Or User can format To delete all files.</p>			

→ The number of saving for capacity

	Embedded memory	Micro SDHC Card		
Capacity	-	4 GByte	16 GByte	32 GByte (MAX)
Still image	50 cuts	128 cuts	128 cuts	128 cuts
The number of Video saving (MAX 120sec)	-	14 cuts	58 cuts	118 cuts

⚠ Caution

1. Please, do not turn on/off, insert or remove Micro SD card during saving, capture image or recording video. It might be caused of malfunction, harm or damage goods. (User may lose data in embedded memory and Micro SD card or it may be reason of malfunction)
2. Recommendation of Micro SD Card [T-FLASH]
 - * SDHC Ultra-3 [3] : 4 ~ 32GByte.
 - * Minimum 30MB/s for reading & writing recommended.
 - * Please use the SD card after formatting it in your PC.
[Instruction : File system → FAT32, Format option → Low format
(Do not click the Quick or Fast format options)]
 - * Warning : If you click the quick or fast format options when you format the SD card, the display quality can be declined.
 - * Please format the SD card once again in the device after insert in it.
 - * Warning : If you do not follow the instructions, the image displaying could be delayed.
3. We recommend check time in product periodically because of time error or difference time.



8. Installation

▶ Monitor installation

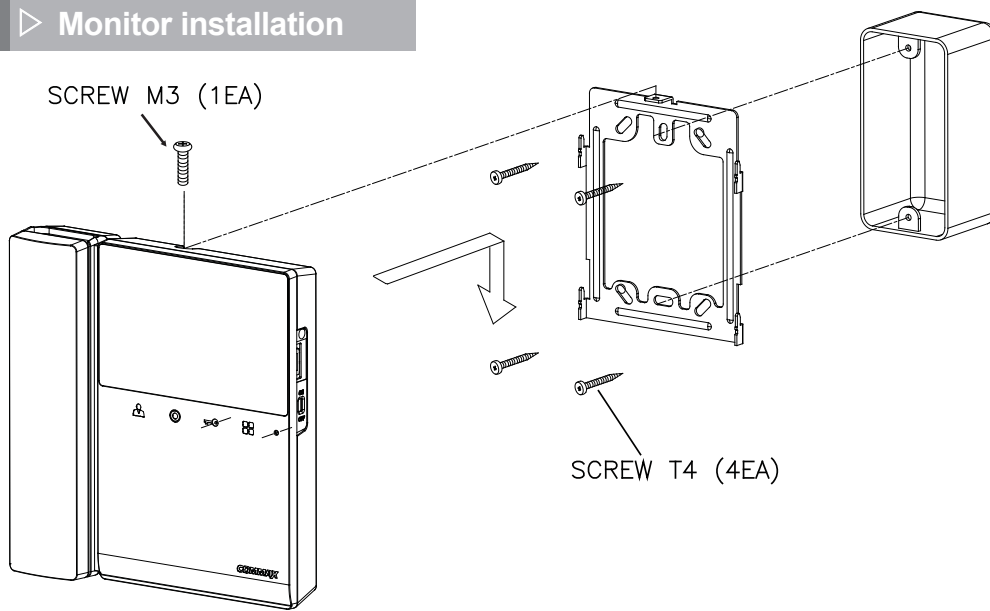

* Note

- Avoid installing the product in the area of direct sunlight.
- The position of the unit's body should fit the standard height range (Recommended height range is 1450 ~ 1500mm.)
- Avoid installing the product exposed to gas exposure, magnetic force, in humid temperatures, as it may damage the condition and performance of the product.

▶ Camera Installation (at DRC-4L)

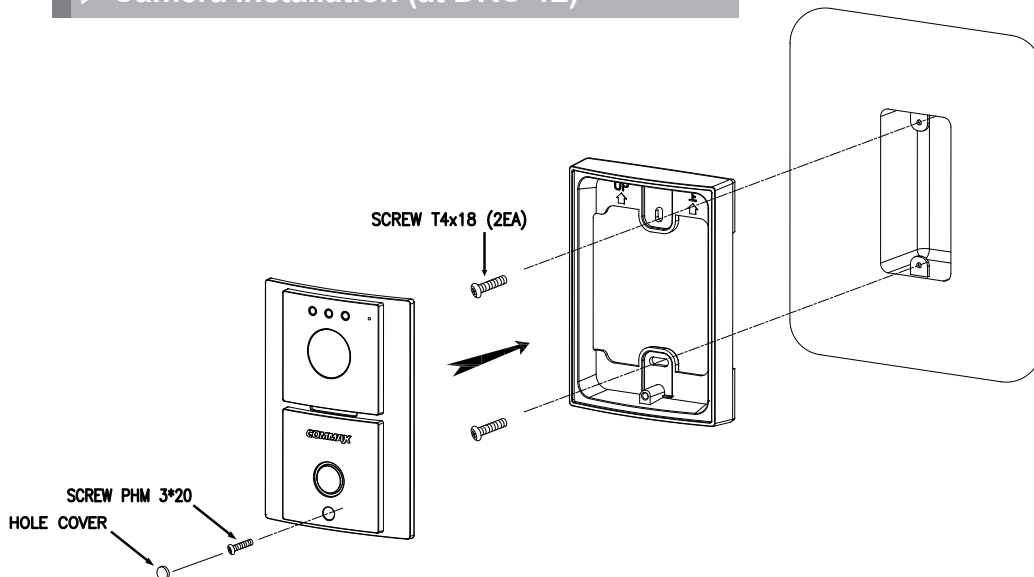

* Note

- Do not install a door camera in the area exposed to direct sunlight or backlight.
- Please keep the lens clean for the clearest image reflection.



9. Specifications and Features

CDV-43KM / CDV-43KM2

Rated Voltage	100-240V~, 50/60Hz
Power Consumption	Standby : 3.7W, Operating : 8W
Wiring	4 wires with door camera (Polarity), 4 wires with an Interphone (Polarity)
Screen Size	Color 4.3" TFT LCD
Communication	Simultaneous communication
Call Sound	From a door camera : Electric chime From an interphone : Beep sound
Time to display the screen	60 ± 10sec
Distance from camera	28m(Φ0.5) / 50m(Φ0.65) / 70m(Φ0.8)
Operating Temperature	0 ~ +40°C (32° F ~ 104° F)

Reference : Design and functions of the product are a subject of constant development as a pursuit of quality improvement



10. Safe Operation guide

- Make sure to turn on the product
- In case if physical damage or operation failure is detected, do not hesitate to contact Service Center
- All electric power must be blocked by the building blocking device
- Do not place water bottles or flowerpots upon the product
- Please, turn the power off when installing or repairing the product
- This apparatus shall not be exposed to dripping or splashing and that no objects filled with liquids, such as vases, shall be placed on the apparatus.
- Plug as disconnection device shall remain to be readily approached by user.



Memo



Memo

COMMAX